

ACCEL. MASS.	QTY.	DESCRIPTION	HEIGHT	REMARKS
4A	ONE	LADDER		
a	2	1. 29 x 75 x 15554		
b	1	2. 29 x 75 x 2946		
c	1	3. 26 x 50 x 1874		
d	2	4. 26 x 50 x 1140		
e	1	5. 26 x 50 x 11885		
f	1	6. 26 x 50 x 11885		
g	1	7. 26 x 50 x 11885		
h	1	8. 26 x 50 x 11885		
i	1	9. 26 x 50 x 11885		
j	1	10. 26 x 50 x 11885		
k	1	11. 26 x 50 x 11885		
l	1	12. 26 x 50 x 11885		
m	1	13. 26 x 50 x 11885		
n	1	14. 26 x 50 x 11885		
o	1	15. 26 x 50 x 11885		
p	1	16. 26 x 50 x 11885		
q	1	17. 26 x 50 x 11885		
r	1	18. 26 x 50 x 11885		
s	1	19. 26 x 50 x 11885		
t	1	20. 26 x 50 x 11885		
u	1	21. 26 x 50 x 11885		
v	1	22. 26 x 50 x 11885		
w	1	23. 26 x 50 x 11885		
x	1	24. 26 x 50 x 11885		
y	1	25. 26 x 50 x 11885		
z	1	26. 26 x 50 x 11885		
aa	1	27. 26 x 50 x 11885		
ab	1	28. 26 x 50 x 11885		
ac	1	29. 26 x 50 x 11885		
ad	1	30. 26 x 50 x 11885		
ae	1	31. 26 x 50 x 11885		
af	1	32. 26 x 50 x 11885		
ag	1	33. 26 x 50 x 11885		
ah	1	34. 26 x 50 x 11885		
ai	1	35. 26 x 50 x 11885		
aj	1	36. 26 x 50 x 11885		
ak	1	37. 26 x 50 x 11885		
al	1	38. 26 x 50 x 11885		
am	1	39. 26 x 50 x 11885		
an	1	40. 26 x 50 x 11885		
ao	1	41. 26 x 50 x 11885		
ap	1	42. 26 x 50 x 11885		
aq	1	43. 26 x 50 x 11885		
ar	1	44. 26 x 50 x 11885		
as	1	45. 26 x 50 x 11885		
at	1	46. 26 x 50 x 11885		
au	1	47. 26 x 50 x 11885		
av	1	48. 26 x 50 x 11885		
aw	1	49. 26 x 50 x 11885		
ax	1	50. 26 x 50 x 11885		
ay	1	51. 26 x 50 x 11885		
az	1	52. 26 x 50 x 11885		
ba	1	53. 26 x 50 x 11885		
bb	1	54. 26 x 50 x 11885		
bc	1	55. 26 x 50 x 11885		
bd	1	56. 26 x 50 x 11885		
be	1	57. 26 x 50 x 11885		
bf	1	58. 26 x 50 x 11885		
bg	1	59. 26 x 50 x 11885		
bh	1	60. 26 x 50 x 11885		
bi	1	61. 26 x 50 x 11885		
bj	1	62. 26 x 50 x 11885		
bk	1	63. 26 x 50 x 11885		
bl	1	64. 26 x 50 x 11885		
bm	1	65. 26 x 50 x 11885		
bn	1	66. 26 x 50 x 11885		
bo	1	67. 26 x 50 x 11885		
bp	1	68. 26 x 50 x 11885		
bq	1	69. 26 x 50 x 11885		
br	1	70. 26 x 50 x 11885		
bs	1	71. 26 x 50 x 11885		
bt	1	72. 26 x 50 x 11885		
bu	1	73. 26 x 50 x 11885		
bv	1	74. 26 x 50 x 11885		
bw	1	75. 26 x 50 x 11885		
bx	1	76. 26 x 50 x 11885		
by	1	77. 26 x 50 x 11885		
bz	1	78. 26 x 50 x 11885		
ca	1	79. 26 x 50 x 11885		
cb	1	80. 26 x 50 x 11885		
cc	1	81. 26 x 50 x 11885		
cd	1	82. 26 x 50 x 11885		
ce	1	83. 26 x 50 x 11885		
cf	1	84. 26 x 50 x 11885		
cg	1	85. 26 x 50 x 11885		
ch	1	86. 26 x 50 x 11885		
ci	1	87. 26 x 50 x 11885		
cj	1	88. 26 x 50 x 11885		
ck	1	89. 26 x 50 x 11885		
cl	1	90. 26 x 50 x 11885		
cm	1	91. 26 x 50 x 11885		
cn	1	92. 26 x 50 x 11885		
co	1	93. 26 x 50 x 11885		
cp	1	94. 26 x 50 x 11885		
cq	1	95. 26 x 50 x 11885		
cr	1	96. 26 x 50 x 11885		
cs	1	97. 26 x 50 x 11885		
ct	1	98. 26 x 50 x 11885		
cu	1	99. 26 x 50 x 11885		
cv	1	100. 26 x 50 x 11885		
cw	1	101. 26 x 50 x 11885		
cx	1	102. 26 x 50 x 11885		
cy	1	103. 26 x 50 x 11885		
cz	1	104. 26 x 50 x 11885		
da	1	105. 26 x 50 x 11885		
db	1	106. 26 x 50 x 11885		
dc	1	107. 26 x 50 x 11885		
dd	1	108. 26 x 50 x 11885		
de	1	109. 26 x 50 x 11885		
df	1	110. 26 x 50 x 11885		
dg	1	111. 26 x 50 x 11885		
dh	1	112. 26 x 50 x 11885		
di	1	113. 26 x 50 x 11885		
dj	1	114. 26 x 50 x 11885		
dk	1	115. 26 x 50 x 11885		
dl	1	116. 26 x 50 x 11885		
dm	1	117. 26 x 50 x 11885		
dn	1	118. 26 x 50 x 11885		
do	1	119. 26 x 50 x 11885		
dp	1	120. 26 x 50 x 11885		
dq	1	121. 26 x 50 x 11885		
dr	1	122. 26 x 50 x 11885		
ds	1	123. 26 x 50 x 11885		
dt	1	124. 26 x 50 x 11885		
du	1	125. 26 x 50 x 11885		
dv	1	126. 26 x 50 x 11885		
dw	1	127. 26 x 50 x 11885		
dx	1	128. 26 x 50 x 11885		
dy	1	129. 26 x 50 x 11885		
dz	1	130. 26 x 50 x 11885		
ea	1	131. 26 x 50 x 11885		
eb	1	132. 26 x 50 x 11885		
ec	1	133. 26 x 50 x 11885		
ed	1	134. 26 x 50 x 11885		
ee	1	135. 26 x 50 x 11885		
ef	1	136. 26 x 50 x 11885		
eg	1	137. 26 x 50 x 11885		
eh	1	138. 26 x 50 x 11885		
ei	1	139. 26 x 50 x 11885		
ej	1	140. 26 x 50 x 11885		
ek	1	141. 26 x 50 x 11885		
el	1	142. 26 x 50 x 11885		
em	1	143. 26 x 50 x 11885		
en	1	144. 26 x 50 x 11885		
eo	1	145. 26 x 50 x 11885		
ep	1	146. 26 x 50 x 11885		
eq	1	147. 26 x 50 x 11885		
er	1	148. 26 x 50 x 11885		
es	1	149. 26 x 50 x 11885		
et	1	150. 26 x 50 x 11885		
eu	1	151. 26 x 50 x 11885		
ev	1	152. 26 x 50 x 11885		
ew	1	153. 26 x 50 x 11885		
ex	1	154. 26 x 50 x 11885		
ey	1	155. 26 x 50 x 11885		
ez	1	156. 26 x 50 x 11885		
fa	1	157. 26 x 50 x 11885		
fb	1	158. 26 x 50 x 11885		
fc	1	159. 26 x 50 x 11885		
fd	1	160. 26 x 50 x 11885		
fe	1	161. 26 x 50 x 11885		
ff	1	162. 26 x 50 x 11885		
fg	1	163. 26 x 50 x 11885		
fh	1	164. 26 x 50 x 11885		
fi	1	165. 26 x 50 x 11885		
fj	1	166. 26 x 50 x 11885		
fk	1	167. 26 x 50 x 11885		
fl	1	168. 26 x 50 x 11885		
fm	1	169. 26 x 50 x 11885		
fn	1	170. 26 x 50 x 11885		
fo	1	171. 26 x 50 x 11885		
fp	1	172. 26 x 50 x 11885		
fq	1	173. 26 x 50 x 11885		
fr	1	174. 26 x 50 x 11885		
fs	1	175. 26 x 50 x 11885		
ft	1	176. 26 x 50 x 11885		
fu	1	177. 26 x 50 x 11885		
fv	1	178. 26 x 50 x 11885		
fw	1	179. 26 x 50 x 11885		
fx	1	180. 26 x 50 x 11885		
fy	1	181. 26 x 50 x 11885		
fz	1	182. 26 x 50 x 11885		
ga	1	183. 26 x 50 x 11885		
gb	1	184. 26 x 50 x 11885		
gc	1	185. 26 x 50 x 11885		
gd	1	186. 26 x 50 x 11885		
ge	1	187. 26 x 50 x 11885		
gf	1	188. 26 x 50 x 11885		
gg	1	189. 26 x 50 x 11885		
gh	1	190. 26 x 50 x 11885		
gi	1	191. 26 x 50 x 11885		
gj	1	192. 26 x 50 x 11885		
gk	1	193. 26 x 50 x 11885		
gl	1	194. 26 x 50 x 11885		
gm	1	195. 26 x 50 x 11885		
gn	1	196. 26 x 50 x 11885		
go	1	197. 26 x 50 x 11885		
gp	1	198. 26 x 50 x 11885		
gq	1	199. 26 x 50 x 11885		
gr	1	200. 26 x 50 x 11885		
gs	1	201. 26 x 50 x 11885		
gt	1	202. 26 x 50 x 11885		
gu	1	203. 26 x 50 x 11885		
gv	1	204. 26 x 50 x 11885		
gw	1	205. 26 x 50 x 11885		
gx	1	206. 26 x 50 x 11885		
gy	1	207. 26 x 50 x 11885		
gz	1	208. 26 x 50 x 11885		
ha	1	209. 26 x 50 x 11885		
hb	1	210. 26 x 50 x 11885		
hc	1	211. 26 x 50 x 11885		
hd	1	212. 26 x 50 x 11885		
he	1	213. 26 x 50 x 11885		
hf	1	214. 26 x 50 x 11885		
hg	1	215. 26 x 50 x 11885		
hh	1	216. 26 x 50 x 11885		
hi	1	217. 26 x 50 x 11885		
hj	1	218. 26 x 50 x 11885		
hk	1	219. 26 x 50 x 11885		
hl	1	220. 26 x 50 x 11885		
hm	1	221. 26 x 50 x 11885		
hn	1	222. 26 x 50 x 11885		
ho	1	223. 26 x 50 x 11885		
hp	1	224. 26 x 50 x 11885		
hq	1	225		

ASSEMBLY	QTY	DESCRIPTION	WEIGHT	REMARKS
9A	4	PLATFORMS		
a	4	C150x25x3 x 2454		
b	4	C150x25x3 x 2454		
c	4	C150x25x3 x 2454		
d	4	C150x25x3 x 1457		
e	4	C150x25x3 x 1891		
f	4	C150x25x3 x 1900		
g	4	C150x25x3 x 1900		
h	4	C150x25x3 x 1900		
i	4	C150x25x3 x 1900		
j	4	C150x25x3 x 1900		
k	4	C150x25x3 x 1900		
l	4	C150x25x3 x 1900		
m	4	C150x25x3 x 1900		
n	4	C150x25x3 x 1900		
o	4	C150x25x3 x 1900		
p	4	C150x25x3 x 1900		
q	4	C150x25x3 x 1900		
r	4	C150x25x3 x 1900		
s	4	C150x25x3 x 1900		
t	4	C150x25x3 x 1900		

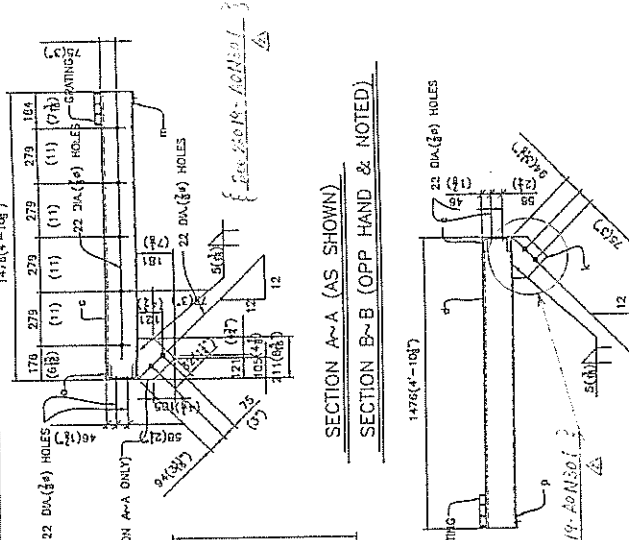

SECTION A~A (AS SHOWN)
SECTION B~B (OPP HAND & NOTED)

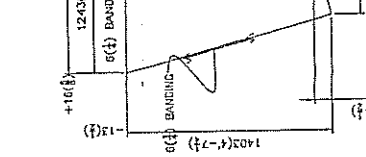
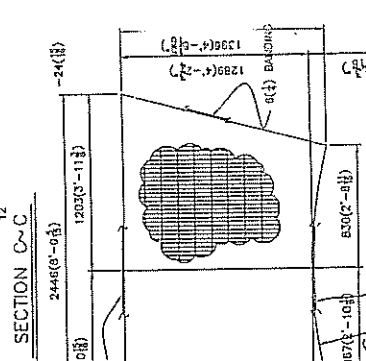
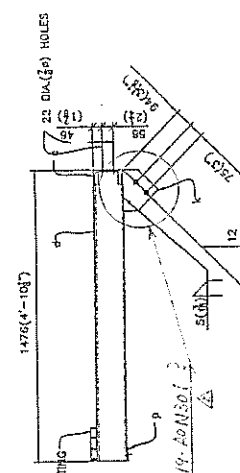

SECTION D~C

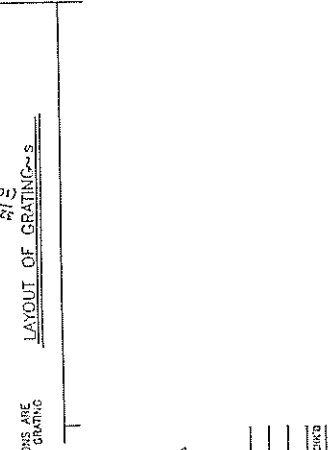
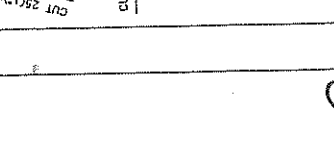
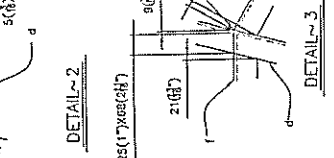
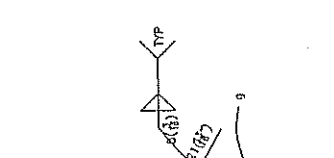
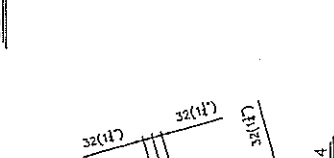
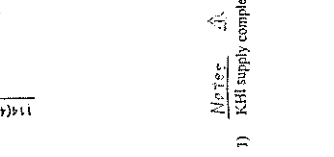

SHOP NOTE:
ALL DIMENSIONS ARE TO EDGE OF GRATING.

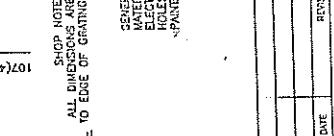

SHOP NOTE:
ALL DIMENSIONS ARE TO EDGE OF GRATING.

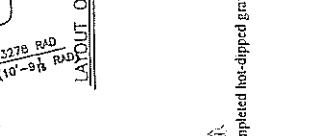

SHOP NOTE:
ALL DIMENSIONS ARE TO EDGE OF GRATING.



SHOP NOTE:
ALL DIMENSIONS ARE TO EDGE OF GRATING.



SHOP NOTE:
ALL DIMENSIONS ARE TO EDGE OF GRATING.

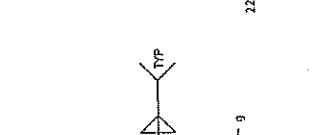

SHOP NOTE:
ALL DIMENSIONS ARE TO EDGE OF GRATING.

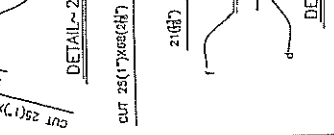

SHOP NOTE:
ALL DIMENSIONS ARE TO EDGE OF GRATING.

GENERAL NOTES:
MATERIAL JMS5400
ELECTRODES E-70W
HOLES AS SHOWN
PAINTED/BLAS/BLANK

Note: KFH supply completed hot-dipped grating.

NO.	DATE	REVISION	MADE BY

QTY	DESCRIPTION	REMARKS
10A	ONE PLATFORM	
10B	ONE PLATFORM	
a	2 C150x75x9 x 2454	
b	2 C150x75x9 x 846	
c	2 C150x75x9 x 1467	
d	2 C150x75x9 x 1891	
e	2 C150x75x9 x 505	
f	2 8.5 x 84 x 127	
g	2 8.5 x 64 x 178	
h	2 SPRINGS 2355 x 2369 x 1326	
i	2 SPRINGS 2255 x 2269 x 1402	
j	2 C160x75x9 x 1328	

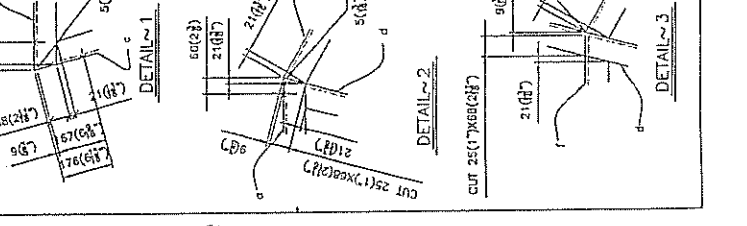
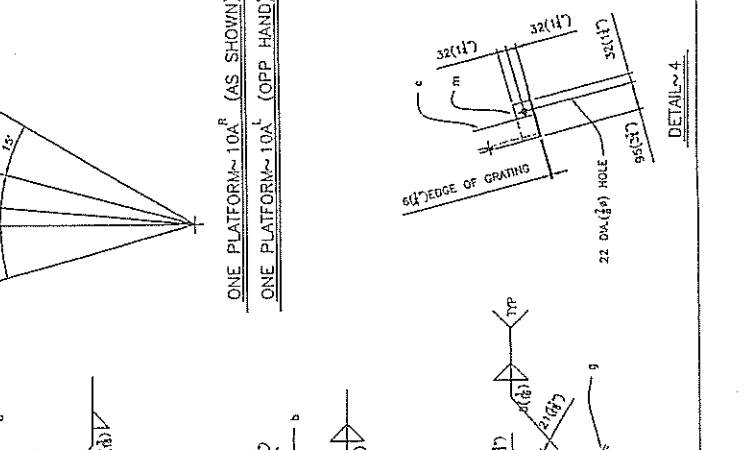
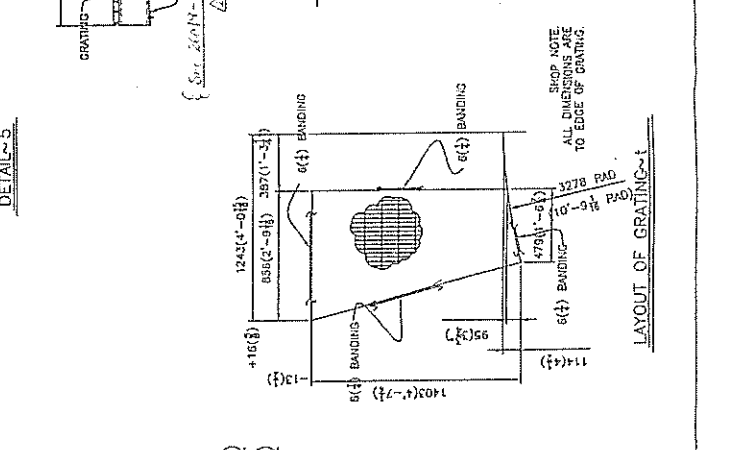
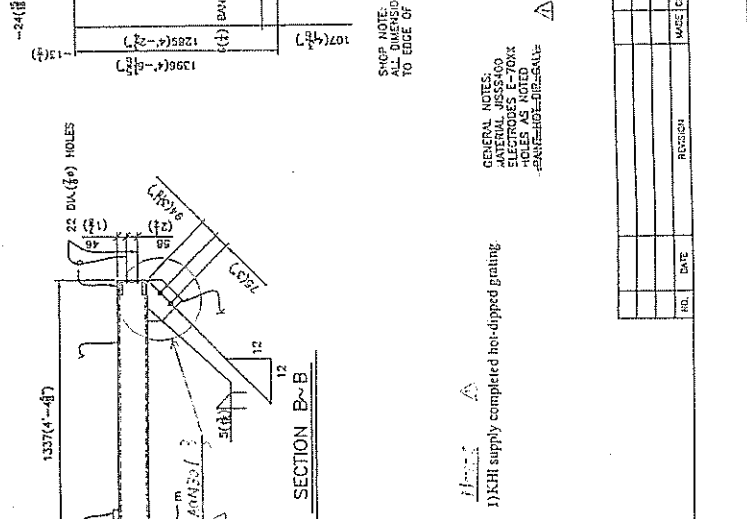
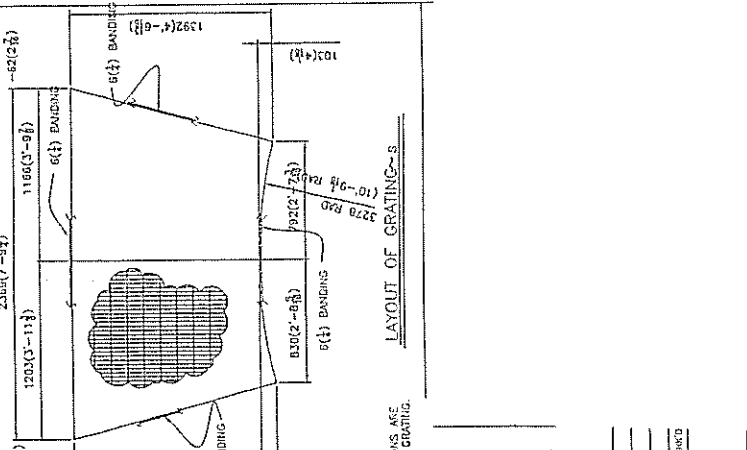
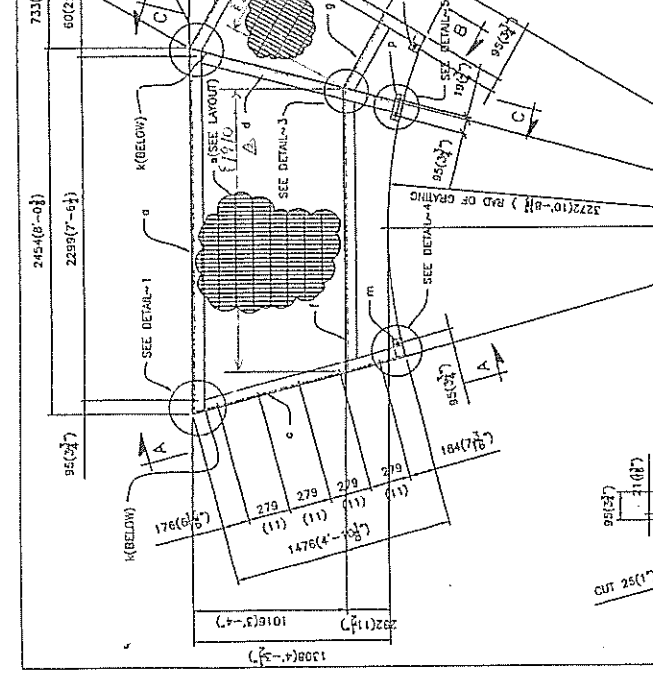
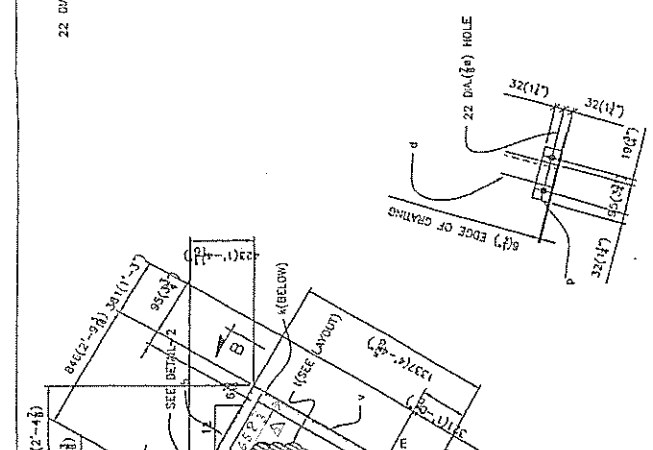
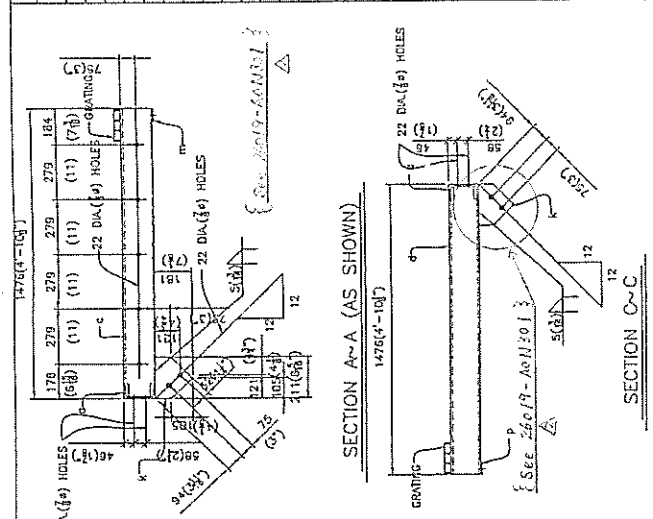

SHOP NOTE:
 ALL DIMENSIONS ARE TO EDGE OF GRATING.

GENERAL NOTES:
 MATERIAL: JESSICO
 ELECTRODEPOSITED
 ZINC-CHROMIUM
 FINISH

SHOP NOTE:
 ALL DIMENSIONS ARE TO EDGE OF GRATING.

SHOP NOTE:
 ALL DIMENSIONS ARE TO EDGE OF GRATING.

SHOP NOTE:
 ALL DIMENSIONS ARE TO EDGE OF GRATING.

SHOP NOTE:
 ALL DIMENSIONS ARE TO EDGE OF GRATING.

SHOP NOTE:
 ALL DIMENSIONS ARE TO EDGE OF GRATING.

NO.	DATE	REVISION	MADE BY/DO

ONE PLATFORM ~ 10A (AS SHOWN)
 ONE PLATFORM ~ 10B (OPP HAND)

DETAIL ~ 2

DETAIL ~ 3

DETAIL ~ 4

NOTE: ALL LIGHTS SHALL BE APPROVED BY THE CITY OF LOS ANGELES. THIS IS A SAMPLE DETAIL WHICH WILL PROVIDE WITH A DETAIL DRAWING OF ACTUAL AVIATION LIGHT AT A LATER DATE.

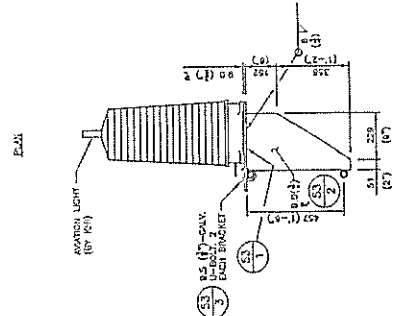
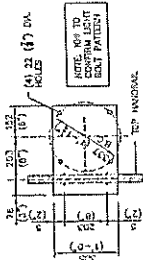

SECTION 1
SCALE 1" = 1'-0"

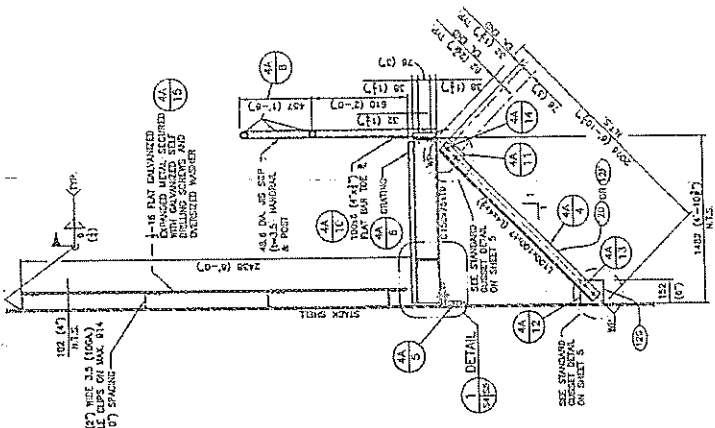

PLAN OF PLATFORM #2
@ EL. 164600 (540'-0 5/16")
SCALE 3/4" = 1'-0"

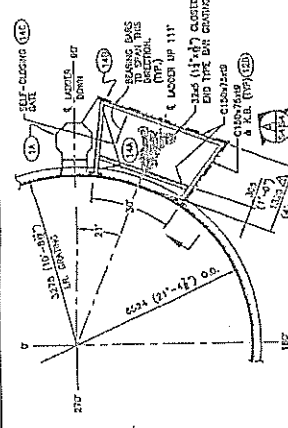

PLAN OF PLATFORM #3
@ EL. 179600 (589'-2 7/8")
SCALE 3/4" = 1'-0"

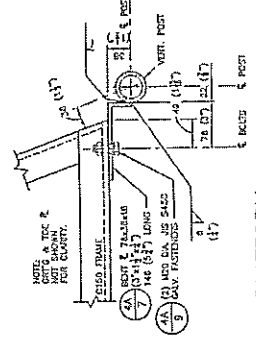

PLATFORM #3
CORNER POST DETAIL
SCALE 3/4" = 1'-0"

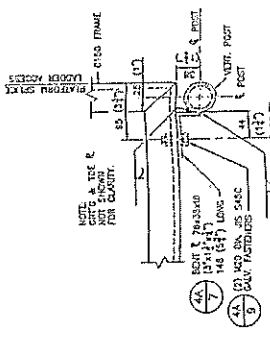

TYP. END POST DETAIL
SCALE 3/4" = 1'-0"

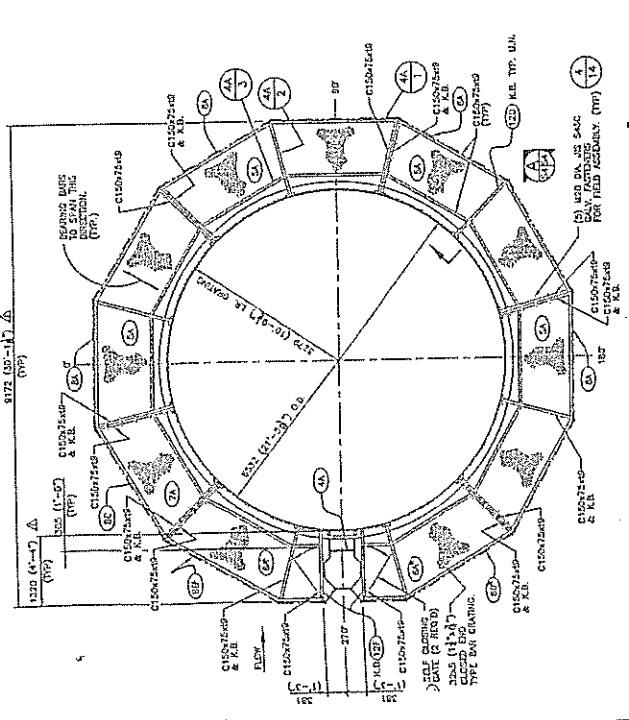

PLAN OF PLATFORM #1 @ EL. 149600 (490'-9 7/8")
SCALE 3/4" = 1'-0"

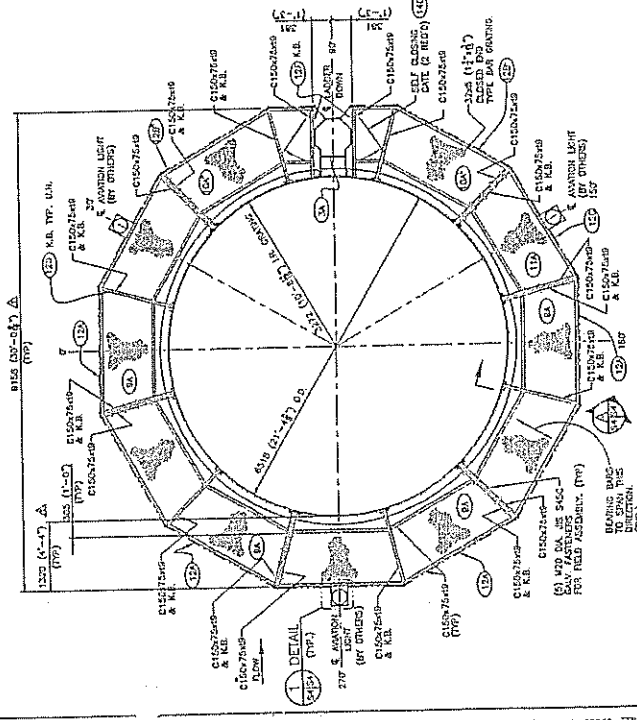

PLAN OF PLATFORM #4 @ EL. 194600 (636'-5 7/16")
SCALE 3/4" = 1'-0"

CERTIFIED FOR CONSTRUCTION

NO.	DATE	REVISION	MADE BY	CHK.

CERTIFIED FOR CONSTRUCTION

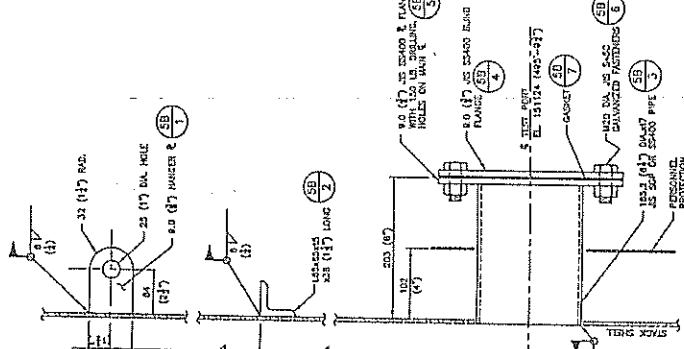
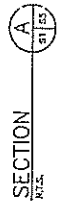
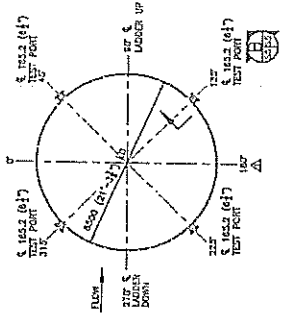
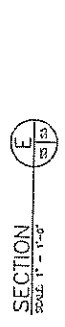
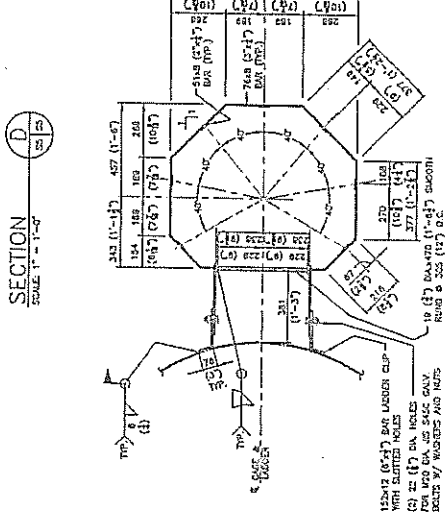
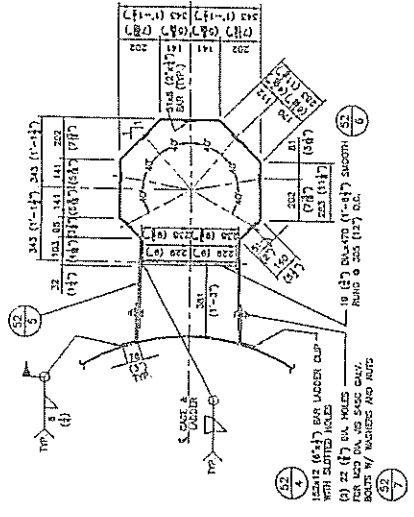

(4 REQ'D) 1/2" DIA. TEST PORT
SECTION
SCALE 3" = 1'-0"

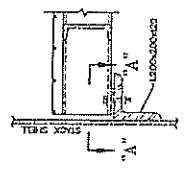
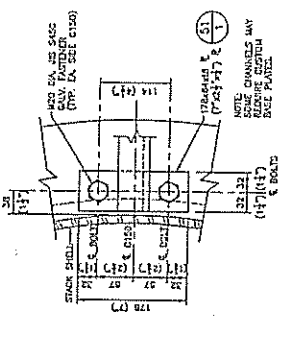
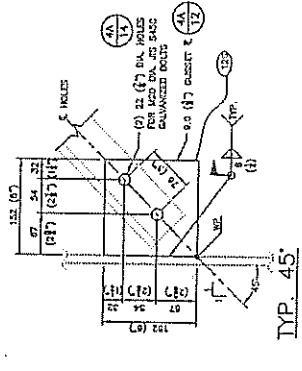
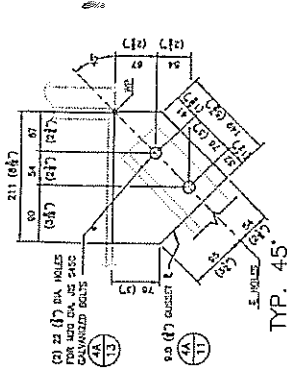
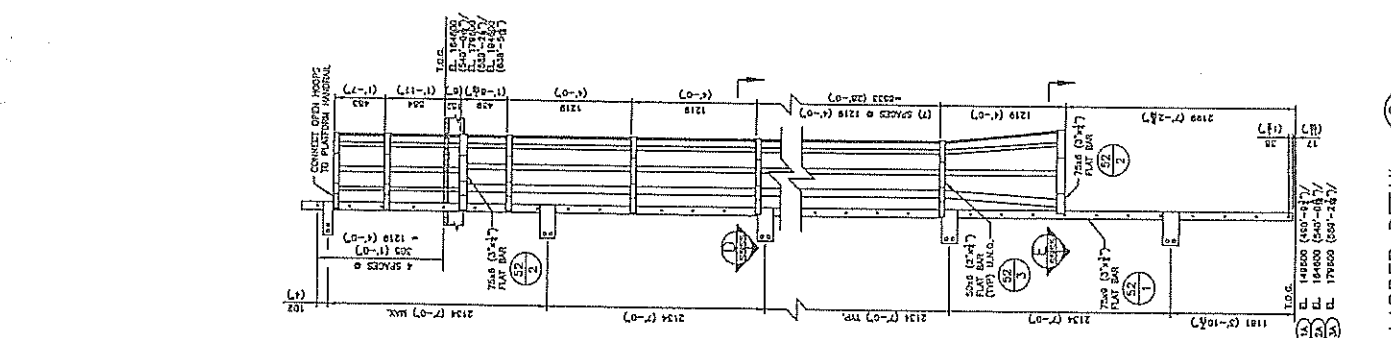
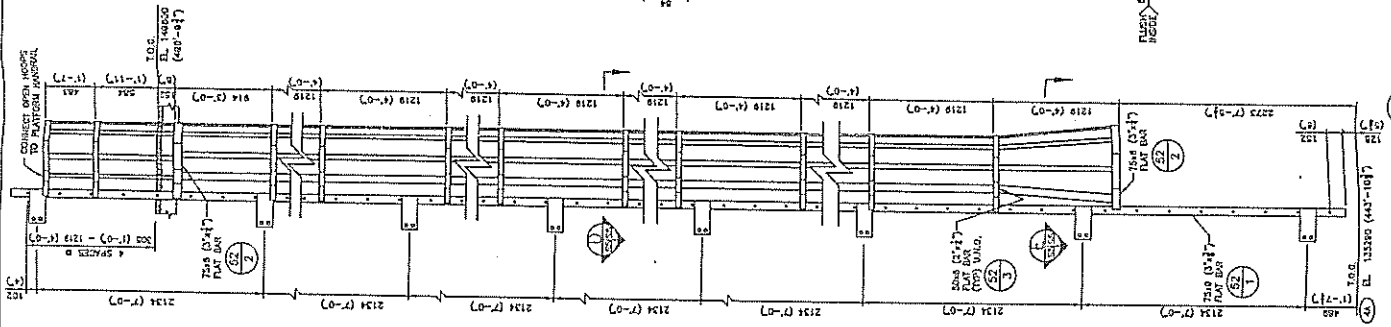

NO.	DATE	REVISION	MADE (DWG.)

LADDER DETAIL 3
SCALE 3" = 1'-0"

LADDER DETAIL 2
SCALE 3" = 1'-0"

DETAIL
SCALE 1" = 1'-0"